

LUXMAN, delivering true sound

The listener deserves heart-felt joy when pursuing natural, uncolored audio reproduction.

This has been our philosophy for over 97 years since our company was founded in 1925.

Enjoy a comforting environment as you become one with the music.



Integrated Amplifier	p3
Control Amplifier	p4
Stereo Power Amplifier	
Vacuum Tube Control Amplifier	p4-p5
Vacuum Tube Stereo Power Amplifier	
Vacuum Tube Integrated Amplifier	p5
Vacuum Tube Compact Disc Player	
Analog Player	p6

Phono Cartridge	p7
Phono Amplifier	
Super Audio CD Player	p8
Compact Disc Player	p9
NeoClassicoII	
Selector	p10
Cable	p11
Accessories	

INTEGRATED AMPLIFIER

L-509Z

NEW

A.T 13.950 €



The L-509Z is a new model and "range topping flagship" of our latest Z-series integrated amplifiers. This "single-chassis separates" concept with high-end sound challenges the performance of stand-alone pre-amps and power amps, having undergone an astonishing evolution from earlier L-509 models. At the heart of the amplifier is our newly developed "LIFES" amplification feedback engine and it is the first to be equipped with a discrete circuit configuration for each of the pre and power sections, bringing an overwhelming power of expression to bear for the new generation. In terms of functionality, it is equipped with a 7-segment LED volume level display, a built-in phono amplifier with a 3-stage gain switching circuit and an additional MIDDLE tone that is useful for adjusting the vocal range. The substantial chassis incorporates many design features from our ultimate M-10X power amplifier including the thick alloy top panel with hairline finish and ventilation ports.

SPECIFICATIONS

Rated output	120 W+120 W (8 Ω) / 240 W+240 W (4 Ω)
Input sensitivity / impedance	PHONO (MM) 2.5 mV / 47 kΩ, PHONO (MC-H) 0.3 mV / 100 Ω, PHONO (MC-L) 0.1 mV / 40 Ω, LINE 180 mV / 47 kΩ
Total harmonic distortion	0.006 % (1 kHz / 8 Ω), 0.06 % (20 Hz to 20 kHz / 8 Ω)
S/N ratio	LINE 106 dB or more
Frequency response	LINE 20 Hz to 150 kHz (within -3 dB)
Power consumption	390 W, 130 W (no signal), 0.4 W (at standby)
Dimensions	440 (W) x 193 (H) x 463 (D) mm
Weight	29.4 kg

INTEGRATED AMPLIFIER

L-507Z

A.T 9.950 €



The L-507Z is the first model introduced to launch our new Z-series of integrated amplifiers. Influenced by the M-10X flagship stereo amplifier, it is equipped with our newly developed "LIFES" amplification feedback engine, an integral feature of the latest LUXMAN amplifiers. Our new LECUA1000 electronically controlled attenuator, discrete buffer circuitry and other high-end specifications make this model a leap forward in musicality far beyond its class. In terms of functionality, the new 7-segment LED volume level display and the newly installed Φ4.4mm headphone output terminal with independent left and right ground wiring, etc., combine audio performance and convenience with ideal proportion and sophistication. It embodies a new style as an all-in-one amplifier.

SPECIFICATIONS

Rated output	110 W+110 W (8 Ω) / 220 W+220 W (4 Ω)
Input sensitivity / impedance	PHONO (MM) 2.5 mV / 47 kΩ, PHONO (MC) 0.3 mV / 100 Ω, LINE 180 mV / 47 kΩ
Total harmonic distortion	0.007 % (1 kHz / 8 Ω), 0.03 % (20 Hz to 20 kHz / 8 Ω)
S/N ratio	LINE 105 dB or more
Frequency response	LINE 20 Hz to 100 kHz (within -3 dB)
Power consumption	350 W, 86 W (no signal), 0.4 W (at standby)
Dimensions	440 (W) x 178 (H) x 454 (D) mm
Weight	25.4 kg

INTEGRATED AMPLIFIER

L-550AXII

Pure A

A.T 6.950 €



The L-550AX Mark II was developed from the earlier L-550AX making its debut featuring our highly precise LECUA electronically controlled attenuator and the ODNF4.0 version of LUXMAN's high quality feedback circuit. We made huge steps forward while developing the previous L-590AX series and the essence of their expressive power was infused into this model to provide the unique characteristics particular to pure class-A amplifiers with more detailed reproduction of the lower ranges.

SPECIFICATIONS

Rated output	20 W+20 W (8 Ω) / 40 W+40 W (4 Ω)
Input sensitivity / impedance	PHONO (MM) 2.5 mV / 47 kΩ, PHONO (MC) 0.3 mV / 100 Ω, LINE 180 mV / 47 kΩ
Total harmonic distortion	0.007 % (1 kHz / 8 Ω), 0.02 % (20 Hz to 20 kHz / 8 Ω)
S/N ratio	LINE 105 dB or more
Frequency response	LINE 20 Hz to 100 kHz (within -3 dB)
Power consumption	230 W, 170 W (no signal), 0.5 W (at standby)
Dimensions	440 (W) x 178 (H) x 454 (D) mm
Weight	24.3 kg

INTEGRATED AMPLIFIER

L-505uXII

A.T 5.450 €



The L-505uXII is the upgraded version of the popular L-505 series, a market leading LUXMAN integrated stereo amplifier range begun with the L-505u. We have loaded L-505uXII with proprietary technologies, such as LUXMAN's ODNF4.0 (Only Distortion Negative Feedback), as well as LECUA (LUXMAN Electronically Controlled Ultimate Attenuator) and a discretely configured buffer circuit for the pre-amp output, same as the LUXMAN C-900u flagship pre-amp model.

SPECIFICATIONS

Rated output	100 W+100 W (8 Ω) / 150 W+150 W (4 Ω)
Input sensitivity / impedance	PHONO (MM) 2.5 mV / 47 kΩ, PHONO (MC) 0.3 mV / 100 Ω, LINE 180 mV / 47 kΩ
Total harmonic distortion	0.009 % (1 kHz / 8 Ω), 0.09 % (20 Hz to 20 kHz / 8 Ω)
S/N ratio	LINE 104 dB or more
Frequency response	LINE 20 Hz to 100 kHz (within -3 dB)
Power consumption	300 W, 85 W (no signal), 0.4 W (at standby)
Dimensions	440 (W) x 178 (H) x 454 (D) mm
Weight	22.5 kg

CONTROL AMPLIFIER

C-900u

End Of Life



The C-900u is another LUXMAN flagship model that achieves a high level of power amplifier drive capability, volume control without sound quality deterioration, and sophisticated functions for a control amplifier. Our original, high-quality ODNF feedback circuitry, which is emblematic of the LUXMAN amplifier family, has been upgraded to ver. 4.0 with further improved distortion exclusion. In addition, four new LECUA1000 electronically controlled attenuators are directly connected to the amplifier modules in fully balanced configuration. Volume control scaling has also increased from the conventional 72 steps to 88 steps, enabling more detailed volume adjustments. In addition, the front panel has a tone control and left/right balance function which can be adjusted without sacrificing sound quality due to its LECUA enhanced circuit design.

SPECIFICATIONS

Input sensitivity / impedance	LINE 255 mV / 43 kΩ, BAL LINE 255 mV / 86 kΩ
Output voltage / impedance	LINE 1 V / 90 Ω, Maximum 11 V, BAL LINE 1 V / 180 Ω, Maximum 22.5 V
Total harmonic Distortion	LINE 0.009 % (20 Hz to 20 kHz), BAL LINE 0.005 % (20 Hz to 20 kHz)
Frequency response	20 Hz to 20 kHz (+0, -0.1 dB), 5 Hz to 120 kHz (+0, -3 dB)
S/N ratio	LINE 123 dB, BAL LINE 126 dB (Maximum output)
Power consumption	42 W, 2.2 W (at standby)
Dimensions	440 (W) x 130 (H) x 430 (D) mm
Weight	19.7 kg

STEREO POWER AMPLIFIER

M-10X

Λ.T 20.900 €



In anticipation of the 100th anniversary of our founding in 2025, returning to the fundamentals of music playback, LUXMAN's milestone and reference to the future has finally been realized. We present the new generation M-10X flagship stereo power amplifier. The amplifier section is equipped with our newly developed "LIFES" amplification feedback engine that realizes "musical density and dynamism" with "strong speaker drivability and a vast sound stage". The M-10X, which has acquired overwhelming high performance, can make all kinds of speakers develop rich musicality, full of vitality, heralding the beginning of a new era for LUXMAN.

SPECIFICATIONS

Rated output	150 W+150 W (8 Ω) / Stereo, 300 W+300 W (4 Ω) / Stereo, 600 W (8 Ω) / Monaural
Maximum power output	1200 W+1200 W (1 Ω) / Stereo, 2400 W (2 Ω) / Monaural
Input sensitivity	1.24 V / 150 W (8 Ω)
Input impedance	Unbalanced 51kΩ, Balanced 28kΩ
Total harmonic distortion	0.003 % or less (1 kHz / 8 Ω), 0.04 % or less (20 Hz to 20 kHz / 8 Ω)
Frequency response	20 Hz to 20k Hz (+0, -0.1 dB), 1 Hz to 130 kHz (+0, -3 dB)
S/N ratio	117 dB
Power consumption	540 W, 290 W (no signal), 1.0 W (at standby)
Dimensions	440 (W) x 224 (H) x 488 (D) mm
Weight	48.4 kg

VACUUM TUBE CONTROL AMPLIFIER

CL-1000

Λ.T 27.500 €



The CL-1000 is a control amplifier that pursues the highest standards across the board. A beautiful rosewood-finish wooden cased and finely machined knobs and levers have a unique presence reminiscent of our classic C-1000. The unit features our high quality, transformer equipped LECUTA* attenuator system and highly reliable JJ Electronic E88CC preamp tubes, realizing abundant dynamism with supreme harmony.

*LECUTA : Luxman Electronically Controlled Ultimate Transformer Attenuator

SPECIFICATIONS

Input sensitivity / impedance	LINE 180 mV / 90 kΩ, BAL LINE 180 mV / 70 kΩ EXT-IN (PHONO) MM 2.2 mV / 100 kΩ, 50 kΩ, 33 kΩ MC-H 0.26 mV / 1 kΩ MC-M 0.26 mV / 40 Ω MC-L 87 μV / 10 Ω
Output voltage / impedance	LINE 1 V / 1 kΩ, Maximum 18 V BAL LINE 1 V / 1 kΩ, Maximum 18 V
Total harmonic Distortion	LINE / BAL LINE 0.016 % (1 kHz)
Frequency response	LINE / BAL LINE 20 Hz to 20 kHz (+0.3, -0 dB) EXT-IN (PHONO) 20 Hz to 20 kHz (±0.3 dB)
S/N ratio (for maximum output)	LINE / BAL LINE 120 dB EXT-IN (PHONO) MM 108dB, MC-H 92dB, MC-M 92dB, MC-L 83dB
Power consumption	52 W
Dimensions	460 (W) x 166 (H) x 454 (D) mm
Weight	24.4 kg

An amplified feedback engine that brings music to life

LIFES* Version 1.0

With our 100th anniversary coming up in 2025, LUXMAN has revamped our ODNF amplifier circuitry, which has long supported the sound quality of our amplifier products since 1999. We have completed a new amplification feedback method with LIFES that achieves excellent audio performance. LIFES is based on the technological concept of the groundbreaking ODNF amplifier circuitry, which achieves excellent static characteristics without feeding back the actual musical component of the signal to the main amplifier, realizing the natural tonality of a non-feedback amplifier. Upgraded and expanded, the circuit has been reviewed from scratch and ideal amplifier performance selected components and repeated listening and rigorous examination, we have perfected a level of performance and sound quality suitable for us in LUXMAN's next-generation audio products.

*LIFES : Luxman Integrated Feedback Engine System

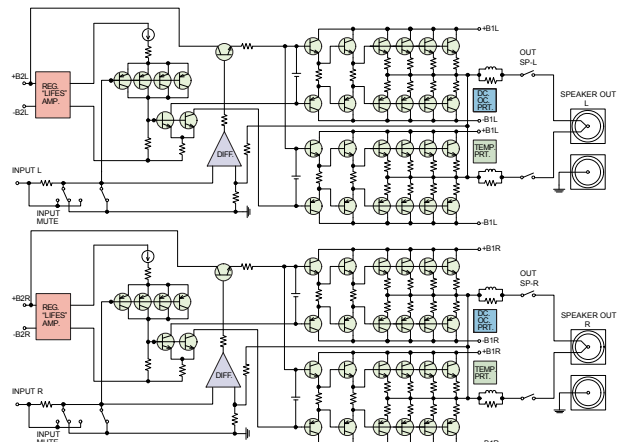

M-10X Output block diagram

VACUUM TUBE CONTROL AMPLIFIER

CL-38uC

Λ.T 6.390 €



The CL-38uC retains a traditional look with its wooden case but the body width is now expanded to a LUXMAN standard size of 440mm (the CL-38u had a width of 400mm) and balanced inputs have been added as our customers have requested. Nichicon-made high voltage metalized polypropylene film coupling capacitors have been introduced for a supple, natural tone.

SPECIFICATIONS

Input sensitivity / impedance	PHONO (MM) 2 mV / 47 kΩ, PHONO (MC high) 0.3 mV / 100 Ω, PHONO (MC low) 0.08 mV / 30 Ω, LINE 190 mV / 50 kΩ
Total harmonic distortion	0.006 % (1 kHz), 0.06 % (20 Hz to 20 kHz)
S/N ratio	PHONO (MM) 68 dB or more, PHONO (MC high) 63 dB or more, PHONO (MC low) 60 dB or more, LINE 100 dB or more
Frequency response	PHONO 20 Hz to 20 kHz (±0.5 dB), LINE 10 Hz to 70 kHz (Within -3 dB)
Power consumption	35 W
Dimensions	440 (W) x 169 (H) x 307 (D) mm
Weight	13.3 kg

VACUUM TUBE STEREO POWER AMPLIFIER

MQ-88uC

Λ.T 6.950 €



*The product comes with a bonnet.

Launched as a matching complement to the CL-38uC, both the interior and exterior of our previous MQ-88u model has been upgraded with many customizations and reborn as the MQ-88uC. Our well-established triode power amp stage inherits that robust mid-to-low range. To enable more powerful reproduction with lower distortion, independent speaker terminals are provided for 4Ω, 8Ω and 16Ω speakers. In addition, the MQ-88uC is full of new charm, both inside and out, such as our adoption of high voltage Nichicon film capacitors and the deep brown exterior finish.

SPECIFICATIONS

Rated output	25 W+25 W (4 Ω, 8 Ω, 16 Ω)
Input sensitivity / impedance	890 mV / 32 kΩ
Total harmonic distortion	0.1 % (1 kHz / 1 W), 0.5 % (20 Hz to 20 kHz / 1 W)
S/N ratio	105 dB
Frequency response	20 Hz to 20 kHz (+0, -0.2 dB), 10 Hz to 100 kHz (+0, -3 dB)
Power consumption	170 W, 140 W (no signal)
Dimensions	440 (W) x 184 (H) x 230 (D) mm
Weight	16.1 kg

VACUUM TUBE INTEGRATED AMPLIFIER

LX-380

Λ.T 8.850 €



The LX-380 represents the 12th generation of our long running 38 series, launched with the SQ-38 in 1963. Our original electronically controlled attenuator LECUA, is now incorporated into a vacuum tube amp for the first time in a traditional design, encased in a wooden cabinet with a full size 440mm front panel. In the power section, the Mullard type driver stage and the push-pull configured 6L6GC output tubes demonstrate their reputation for evoking even the most delicate, soft tones in this application. The excellent semiconductor circuitry and control system which comprises the first stage of this great unit ensures high performance and long-term stability. The latest technology exquisitely combines with traditional know-how and a musical, rich tube output brings out the enthusiast-focused attraction of hybrid tube-loaded integrated amplifier.

SPECIFICATIONS

Rated output	20 W+20 W (6 Ω) / 18 W+18 W (8 Ω) / 14W+14W (4 Ω)
Input sensitivity / impedance	PHONO (MM) 3.0 mV / 47 kΩ, PHONO (MC) 0.38 mV / 100 Ω, LINE 180 mV / 47 kΩ
Total harmonic distortion	1 % (1 kHz / 6 Ω)
S/N ratio	LINE 95 dB or more
Frequency response	LINE 20 Hz to 80 kHz (within -3 dB)
Power consumption	127 W
Dimensions	440 (W) x 197 (H) x 403 (D) mm
Weight	17.6 kg

VACUUM TUBE CD PLAYER

D-380

Λ.T 5.400 €



As the successor to the D-38u, a long-selling product since its launch in 2009, the D-380, in its traditional wooden case, has evolved, featuring a switching function for earlier solid state or vacuum tube output circuitry. The ECC82-loaded vacuum tube output stage is equipped with a large output transformer and dedicated buffer circuitry. The digital path features newly introduced Texas Instruments jitter reduction ICs. The core processors are Texas Instruments 32bit compatible PCM5102A DAC chips, furthermore, by redesigning the drive mechanism and chassis structure, we improved basic mechanical performance as a dedicated CD player, while acquiring a density of expression unique to vacuum tube output stage.

SPECIFICATIONS

Supported media	CD, CD-R, CD-RW
Analog output	LINE x 1
Digital output	Coaxial x 1, Optical x 1
Output voltage / impedance	Solid state 2.1 V / 300 Ω, Vacuum tube 2.4 V / 300 Ω
Frequency response	Solid state 20 Hz to 20 kHz (+0, -0.2 dB), Vacuum tube 20 Hz to 20 kHz (+0.1, -0.3 dB)
Total harmonic distortion	Solid state 0.005 %, Vacuum tube 0.8 %
S/N ratio	Solid state 115 dB, Vacuum tube 105 dB
Power consumption	16 W
Dimensions	440 (W) x 167 (H) x 286 (D) mm
Weight	10.8 kg

BELT DRIVE ANALOG PLAYER

PD-191A

NEW

A.T 13.950 €



*Dust cover is sold separately

It has been some years since the release of the original PD-171 which pioneered the current analog boom. The PD-191A is a redesign that incorporates the latest technology and knowledge gained during that time. Based on a belt drive system that uses a brushless DC motor which maintains accurate rotation through a high-precision PID control, it is equipped with our newly designed, original LTA-710 knife-edge bearing tonearm system, jointly developed with SAEC (Saec Commerce Co., Ltd) that has excellent initial sensitivity. By setting the effective length to 10 inches, tracking errors are suppressed and surface vibration damping is enhanced.

SPECIFICATIONS

Turntable drive section

Drive system	Belt drive system
Motor	Brushless DC motor with PID control
Materials	Machined aluminum, Surface finish: Diamond cut
Revolution	33 1/3 rpm, 45 rpm, 78 rpm (3 speeds selectable)
Revolution adjustment range	±6 % (each rotation speed adjustable independently)
Wow and flutter	0.04 % or less (W.R.M.S.)
Weight	5.2 kg (platter)

Tonearm section

Type	Static balanced, S shaped, universal type
Bearing	Concealed vertical knife edge
Effective length	256 mm
Overhang	16 mm
Tracking error angle	+1.07° to -1.52°
Suitable cartridge weight	4 to 11 g (Including head shell 17 to 24 g)
Adjustable height range	22 mm
Anti-skating bia	0 to 4 g

Main unit

Power consumption	6 W
Dimensions	491 (W) x 128 (up to top face of platter) (H) x 399 (D) mm
Weight	24.8 kg

BELT DRIVE ANALOG PLAYER

PD-151 MARK II

NEW

A.T 6.290 €



*Dust cover is sold separately

Our PD-151 MARK II turntable succeeds the PD-151, launched in 2018, and is equipped with an original, static balance tone arm that adopts knife edge technology developed by SAEC and exhibits excellent initial sensitivity. By giving the arm a universal connection, it is easy to install a replacement cartridge. Equipped with a high-torque, brushless DC motor, precise platter rotation speed is controlled by a 3 stage switching system (33 1/3, 45, 78 rpm). This new standard, belt-drive analog player has evolved further based on the reliable performance and functional beauty of its predecessor.

SPECIFICATIONS

Turntable drive section

Drive system	Belt drive system
Motor	Brushless DC motor with PID control
Materials	Machined aluminum, Surface finish: Diamond cut
Revolution	33 1/3 rpm, 45 rpm, 78 rpm (3 speeds selectable)
Revolution adjustment range	±6 % (each rotation speed adjustable independently)
Wow and flutter	0.04 % or less (W.R.M.S.)
Weight	4.0 kg (platter)

Tonearm section

Type	Static balanced, S shaped, universal type
Bearing	Concealed knife edge
Effective length	222.5 mm
Overhang	18 mm
Tracking error angle	±3° or less
Suitable cartridge weight	4 to 10 g (Including head shell 17 to 23 g)
Adjustable height range	15 mm
Anti-skating bia	0 to 4 g

Main unit

Power consumption	6 W
Dimensions	465 (W) x 133 (up to top face of platter) (H) x 393 (D) mm
Weight	15.8 kg

Accessories (available service parts)

Dust cover

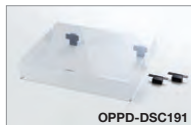

OPPD-DSC191

PD-191A
PD-171A PD-171AL

4mm thick acrylic,
cam support hinges

Heavy weight



OPPD-HW3

PD-191A

For cartridges of 10 to 19g
(23 to 32g including headshell)



OPPD-HW2

PD-151MARK II

For cartridges of 9 to 19g
(22 to 32g including headshell)

Headshell



OPPD-SH3

PD-191A
PD-151MARK II PD-151

PD-171A PD-171AL

PD-171

Machined aluminum
light weight type weight 13g
(including D.U.C.C. lead wires)



OPPD-SH2

PD-191A
PD-151MARK II PD-151

PD-171A PD-171AL

PD-171

Machined aluminum
light weight type weight 13g
(including OFC lead wires)

Rubber drive belt



PD-191A
PD-151MARK II PD-151

PD-171A PD-171AL

PD-171

Replacement arm base with brass chrome-plated finish



OPPD-AB1

PD-191A
PD-171A PD-171AL

For SME 3009R/3010R,
Series M2-9R/9/10/IV/V



OPPD-AB2

PD-191A
PD-171A PD-171AL

For FR 64/64S/64FX,
IKEDA IT-345



OPPD-AB3

PD-191A
PD-171A PD-171AL

For SAEC WE-308



OPPD-AB4

PD-191A
PD-171A PD-171AL

For SAEC WE-407/23



OPPD-AB5

PD-191A
PD-171A PD-171AL

For ORTOFON 212S/212D
OPPD-AB6

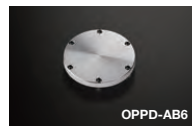

OPPD-AB6

PD-191A
PD-171A PD-171AL

DIY universal tonearm base



Long arm base OPPD-AB11L

PD-191A

For SME 3012 (12 inches)

LMC-5

A.T 2.490 €

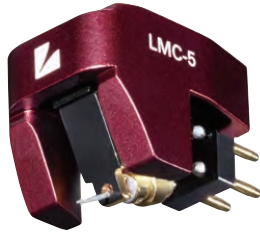

The LMC-5 is LUXMAN's latest original cartridge system, the first for almost 40 years since the LMC-1 was launched in 1981 and the LMC-2 in 1982. For the moving coil generator engine, we selected a cross-shaped iron core that has a compact magnetic circuit and improved efficiency, and for the vibration system, we selected a combination of an aluminum alloy cantilever that boasts excellent tracing ability and a Shibata stylus. Furthermore, thanks to our unique housing structure, which we have perfected through repeated auditions, we have created a cartridge that delivers natural, relaxed tone.

SPECIFICATIONS

Type	MC (MOVING COIL)
Internal impedance	4.7 Ω (1 kHz)
Tracking force	2.1 to 2.3 g (2.2 g as standard)
Output voltage	0.4 mV (1kHz, 3.54 cm / sec.)
Frequency response	10 Hz to 35 kHz
Channel separation / balance	28 dB (1 kHz) / 0.5 dB (1 kHz)
Recommended load impedance	40 Ω or more
(When head amplifier is connected)	
Recommended load impedance	2.5 to 10 Ω
(When step-up transformer is connected)	
Dynamic compliance	8 x 10 ⁻⁶ cm / dyne (100 Hz)
Stylus	Solid diamond / SHIBATA needle
Cantilever	Φ0.5 mm aluminum
Vertical tracking angle	25°
Magnet	Samarium-cobalt magnet BH20
Coil	30 μm UEW
Material of magnetic circuit	Pure iron
Terminals	Φ1.2 mm, White (L+), Blue (L-), Red (R+), Green (R-)
Body	Aluminum A6063
Dimensions, Threaded holes	17.0 (W) x 18.3 (H) x 21.3 (D) mm, M2.6 mm x 2
Weight	8.5 g

Dimensions (mm)

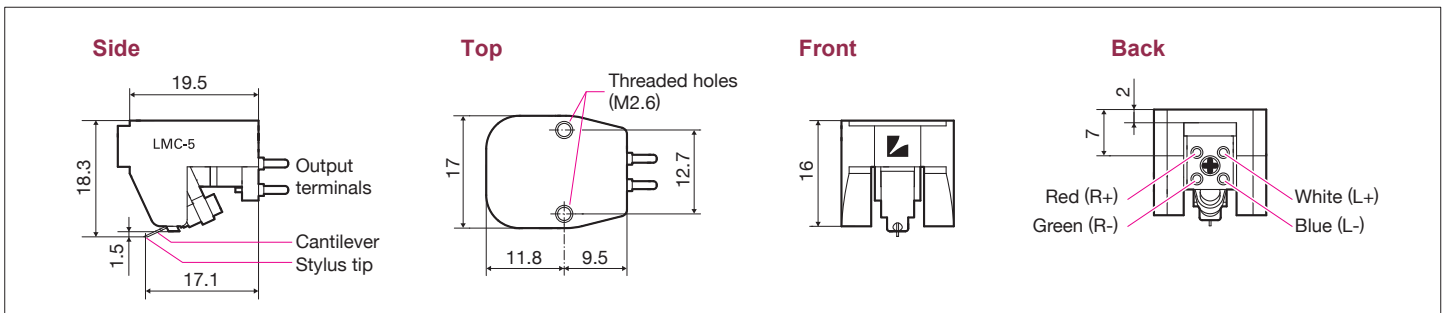

E-250

A.T 2.450 €



The E-250 allows the listener to fine tune settings for any recorded performance, releasing the expression engraved in the grooves of vinyl discs and creating a profound musical impression. The rear panel is equipped with an impedance selector and a load capacity selector to match the characteristics of the selected cartridge, exploiting the output to its full potential. The E-250 features a step-up transformer with a 2-stage gain sector with independent left and right circuitry. The super permalloy core supports even low impedance MC cartridges. This creates a rich and expressive musicality that is a unique characteristic of this type of transformer.

SPECIFICATIONS

Circuiting system	NF type equalizer (RIAA)
Input sensitivity / impedance	MM 3.2 mV / 34 kΩ, 47 kΩ, 56 kΩ, 100 kΩ (switchable), MC high 0.37 mV / 40 Ω, MC low 0.12 mV / 2.5 Ω
Gain	MM 38 dB, MC high 57 dB, MC low 66 dB
Output voltage / impedance	250 mV / 300 Ω
S/N ratio	MM 90 dB, MC high 83 dB, MC low 80 dB
Power consumption	7 W
Dimensions	364 (W) x 81 (H) x 274 (D) mm
Weight	4.3 kg

D-10X

A.T 17.700 €



The D-10X is the flagship model of Super Audio CD player / DAC equipped with our latest LxDTM-i transport mechanism to read signals with high accuracy with its increased rigidity and mass delivering highly stable disc rotation. The digital circuits feature the latest ROHM high specification DAC technology that supports PCM 768kHz/32bit and DSD 22.4MHz/1bit. The two BD34301EKV chipsets are employed in monaural mode for ultimate fidelity. Conversion to analog signals is achieved with the fully balanced discrete amplifier circuits reproducing the source information with rich musicality and unusual expressiveness. In addition, by reducing the load between transmission and reception in USB, Bulk Pet* that enables high quality and stable file playback, and full decoding support for MQA-CD* / MQA* files, etc., can be used in all diversifying source environments and realize reproduction of high-quality sound.

SPECIFICATIONS

Supported media	SACD, CD, CD-R, CD-RW, MQA-CD
Analog output	LINE x 1, BAL LINE x 1
Supported sampling frequency	USB input (PCM) 44.1 kHz, 48 kHz, 88.2 kHz, 96 kHz, 176.4 kHz, 192 kHz, 352.8 kHz, 384 Hz, 705.6 Hz, 768 Hz (16, 24, 32 bit)
USB input (DSD)	2.8 MHz, 5.6 MHz, 11.2 MHz, 22.4 MHz (1bit)
COAX / OPT input	44.1 kHz, 48 kHz, 88.2 kHz, 96 kHz, 176.4 kHz, 192 kHz (16, 20, 24 bit)
Digital input	USB (Type-B) x 1, COAX x 1, OPT x 2
Digital output	COAX x 1, OPT x 1
Output voltage / impedance	LINE 2.4 V / 300 Ω, BAL LINE 2.4 V / 600 Ω, SACD / DSD 1.3V
Frequency response	CD 5 Hz to 20 kHz (+0, -1 dB), SACD 5 Hz to 38 kHz (+0, -3 dB), USB 5 Hz to 47 kHz (+0, -3 dB)
Total harmonic distortion	CD 0.0018 %, SACD 0.001 %, USB 0.0015 %
S/N ratio	CD 125 dB, SACD 121 dB, USB 125 dB
Power consumption	48 W, 1 W (standby)
Dimensions	440 (W) x 154 (H) x 418 (D) mm
Weight	22.4 kg

*LUXMAN Audio Player or the driver software is available for download on our website.

D-07X

NEW

A.T 11.950 €



The D-07X is a very high specification SACD / CD player / DAC that truly inherits much of the performance of the flagship premium model D-10X. The drive mechanism is equipped with the original high-rigidity mechanism LxDTM-i, achieving high rigidity and signal reading accuracy. Like the D-10X, the D/A converter adopts ROHM's "MUS-IC" series top-end DAC chip BD34301EKV in a dual mono configuration. At the time of USB input, it supports up to PCM768kHz/32bit, DSD22.4MHz, and the full decode playback to MQA-CD* / MQA*files is also possible.

SPECIFICATIONS

Supported media	SACD, CD, CD-R, CD-RW, MQA-CD
Analog output	LINE x 1, BAL LINE x 1
Supported sampling frequency	USB input (PCM) 44.1 kHz, 48 kHz, 88.2 kHz, 96 kHz, 176.4 kHz, 192 kHz, 352.8 kHz, 384 Hz, 705.6 Hz, 768 Hz (16, 24, 32 bit)
USB input (DSD)	2.8 MHz, 5.6 MHz, 11.2 MHz, 22.4 MHz (1bit)
COAX / OPT input	44.1 kHz, 48 kHz, 88.2 kHz, 96 kHz, 176.4 kHz, 192 kHz (16, 20, 24 bit)
Digital input	USB (Type-B) x 1, COAX x 1, OPT x 1
Digital output	COAX x 1, OPT x 1
Output voltage / impedance	LINE 2.4 V / 300 Ω, BAL LINE 2.4 V / 600 Ω, SACD / DSD 2.3V
Frequency response	CD 5 Hz to 20 kHz (+0, -1 dB), SACD 5 Hz to 38 kHz (+0, -3 dB), USB 5 Hz to 47 kHz (+0, -3 dB)
Total harmonic distortion	CD 0.0016 %, SACD 0.0007 %, USB 0.001 %
S/N ratio	CD 122 dB, SACD 125 dB, USB 122 dB
Power consumption	37 W, 1 W (standby)
Dimensions	440 (W) x 132 (H) x 410 (D) mm
Weight	17.0 kg

*LUXMAN Audio Player or the driver software is available for download on our website.

LUXMAN original music playback software

LUXMAN has developed an original music playback software system, LUXMAN Audio Player. It is a bespoke software player, providing high quality audio playback over USB on both Windows PC and Mac. This software can handle the regular formats used by major distribution sites such as FLAC, ALAC, WAV, AIFF, MP3 and DSF / DSDIFF.



LUXMAN Audio Player

*LUXMAN Audio Player (Windows 10 or newer / macOS 10.15 or newer) and driver software for Windows can be downloaded from the our website.

*Apple Mac, Mac OS, OS X, macOS and Macintosh are trademarks of Apple Inc., registered in the U.S. and other countries.

*Microsoft and Windows is a registered trademark of Microsoft Corporation in the U.S. and other countries.

*MQA is a registered trade marks of MQA Limited.(c) 2018 *MQA-CD is a registered trade mark of MQA Limited.(c) 2017 *Bulk Pet is a registered trademark of Interface Co., Ltd.

CD PLAYER

D-03X

Λ.T 5.300 €



The D-03X is equipped with a highly reliable, dedicated CD transport mechanism to improve accuracy, provide stable operation and reduce noise when reading discs. It delivers high quality amplification via fully balanced output circuitry. The D/A converter features dual Texas Instruments PCM 1795 chips to handle high resolution files. The USB input supports PCM data up to 384 kHz / 32-bit and DSD files up to 11.2 MHz / 1 bit with high precision signal processing. In addition, the newly supported Bulk Pet transfer has expanded the options for high-quality and stable file playback by reducing load between sender and receiver. Increasing numbers of titles feature MQA-CD / MQA encoded files are fully supported. Both CD playback, which is still at the center of listener's collections, and diversified digital file / data playback can be achieved with high quality.

SPECIFICATIONS

Supported media	CD, CD-R, CD-RW, MQA-CD
Analog output	LINE x 1, BAL LINE x 1
Supported sampling frequency	USB input (PCM) 44.1 kHz, 48 kHz, 88.2 kHz, 96 kHz, 176.4 kHz, 192 kHz, 352.8 kHz, 384 kHz (16, 24, 32 bit) USB input (DSD) 2.8 MHz, 5.6 MHz, 11.2 MHz (1bit) COAX / OPT input 44.1 kHz, 48 kHz, 88.2 kHz, 96 kHz, 176.4 kHz, 192 kHz (16, 20, 24 bit)
Digital input	USB (Type-B) x 1, COAX x 1, OPT x 1
Digital output	COAX x 1, OPT x 1
Output voltage / impedance	LINE 2.4 V / 300 Ω, BAL LINE 2.4 V / 600 Ω, DSD 1.7 V
Frequency response	CD 5 Hz to 20 kHz (+0, -1 dB), COAX / OPT / USB 5 Hz to 47 kHz (+0, -3 dB)
Total harmonic distortion	CD 0.003 %, COAX / OPT / USB 0.002 %
S/N ratio	CD 101 dB, COAX / OPT 114 dB, USB 113 dB
Power consumption	18 W
Dimensions	440 (W) x 133 (H) x 410 (D) mm
Weight	13.2 kg

*LUXMAN Audio Player or the driver software is available for download on our website.

NeoClassico II ——— Return home to a space filled with beautiful sound

VACUUM TUBE INTEGRATED AMPLIFIER

SQ-N150

Λ.T 4.300 €



*The product comes with a bonnet.

Our NeoClassico line features this compact and stylish A4 sized vacuum tube integrated amplifier at the core of the series, offering an attractive level of audio quality. It has undergone a complete transformation. With newly designed components suitable for a high-end model, while staying true to our original concept. Simplified circuitry, utilizing EL84 vacuum tubes in push-pull configuration, produces an output of 10 watts per channel, placing importance on enjoying this unit's excellence for an extended lifespan. Improvements, including the addition of a new analog level meter, balance adjustment and MC cartridge input, further enhance this complete integrated amplifier.

SPECIFICATIONS

Rated output	10 W+10 W (6 Ω)
Input sensitivity / impedance	PHONO (MM) 3.0 mV / 47 kΩ, PHONO (MC) 0.33 mV / 100 Ω, LINE 180 mV / 47 kΩ
Total harmonic distortion	1 % or less (1 kHz / 6 Ω)
S/N ratio	LINE 95 dB or more
Frequency response	LINE 20 Hz to 80 kHz (within -3 dB)
Power consumption	98 W
Dimensions	297 (W) x 188 (H) x 251 (D) mm
Weight	12.4 kg

CD PLAYER

D-N150

Λ.T 3.650 €



The D-N150 CD player, a matching complement to the SQ-N150, is equipped with Texas Instruments PCM5102A DAC chips, which can handle audio encoding up to 192kHz/32 bit, and a highly reliable LUXMAN transport mechanism, known for stable and accurate disc reading, featured in our D-380 CD player. Newly equipped with coaxial, optical and USB terminals for digital inputs, it can also be used as a digital audio hub. The remote control allows player control and amplifier volume adjustment. The NeoClassico II series suspends time by relaxing and immersing the listener in the music with favorably designed and truly enjoyable products.

SPECIFICATIONS

Supported media	CD, CD-R, CD-RW
Analog output	LINE x 1
Supported sampling frequencies	USB input (PCM) 32 kHz, 44.1 kHz, 48 kHz, 88.2 kHz, 96 kHz, 176.4 kHz, 192 kHz (16, 24, 32 bit), COAX / OPT input (PCM) 32 kHz, 44.1 kHz, 48 kHz, 88.2 kHz, 96 kHz, 176.4 kHz, 192 kHz (16, 20, 24 bit)
Digital input	USB x 1, COAX x 1, OPT x 1
Digital output	OPT x 1
Frequency response	CD 5 Hz to 20 kHz (+0, -0.5 dB), COAX / OPT / USB 5 Hz to 50 kHz (+0, -3 dB)
Total harmonic distortion	CD 0.005 %, COAX / OPT / USB 0.005 %
S/N ratio	CD 110 dB, COAX / OPT / USB 110 dB
Power consumption	13 W
Dimensions	297 (W) x 98 (H) x 222 (D) mm
Weight	5.0 kg

SYSTEM SELECTOR

Switch the system and enjoy comparing the expressions of music. This is a series of high-definition system selectors to enable enjoyment of the epitome of audio. In order to avoid noise through the circuit loop, LUXMAN, striving for sound quality, introduces switching for each ground line, adopting highly pure gold-plated terminals, and discrete wiring. Furthermore, 6N (99.99997% pure) wire is used for the wiring material in the AS-44 and AS-55, and it is composed of a grade suitable for a high-end separate amplifier. In addition, the latest refined models of the long-selling AS-4/AS-5, AS-4(III) and AS-5(III) models have an additional index space to further improve usability. The AS-50R sees the introduction of a remote control, allowing you to comfortably switch between multiple systems while in the listening position.

4-LINE RCA TERMINAL TYPE COAXIAL LINE SELECTOR

AS-44

A.T 770 €

The AS-44 is a passive, high-quality audio selector that can switch up to four audio devices over an RCA network. To match high-end separate amplifiers, the unit is of the highest quality, with a highly rigid aluminum housing. All the internal wiring is 6N (99.99997 % pure) copper wire, purity retains quality and prevents information loss. The RCA terminals are also plated with highly pure gold. There is no compromise in sound quality considerations. This unit can be used as a source selector for switching between CD players, tuners, and D / A converters, or as an amplifier selector that switches and shares one source with multiple amplifiers.

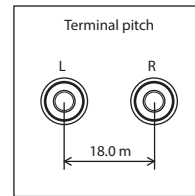

SPECIFICATIONS

Dimensions	370 (W) x 71 (H) x 136 (D) mm
Weight	2.4 kg

3-LINE SPEAKER TERMINAL TYPE SPEAKER SELECTOR

AS-55

A.T 990 €

The AS-55 is a speaker terminal type, passive, high-quality audio selector that can switch between three speaker outputs. The high quality construction matches high-end separate amplifiers, with a highly rigid aluminum housing, 20 A rotary switch to select output signals and 6N (99.99997 % pure) copper wire used for internal connections. Bare wire, spade or banana plugs can be connected to these high grade speaker output terminals. Using this unit enables the listener select between three amplifier inputs for three separate speaker systems.

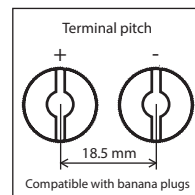

SPECIFICATIONS

Dimensions	370 (W) x 71 (H) x 164 (D) mm
Weight	3.0 kg
Speaker terminal	Supported Y-lug terminal dimension
Width of part a :	17 mm or less
Width of part b :	8 mm or more



* Connection may not be performed depending on the shape of the Y-lug terminal.

3-LINE SPEAKER TERMINAL TYPE SPEAKER SELECTOR

AS-50R

A.T 690 €

The AS-50R is a speaker terminal type audio selector which enables switching between three speaker outputs and also supports remote control operation. Switching is made possible by using a 5 A, high capacity speaker relay that is discretely controlled by the main unit or the included remote control. You can switch between multiple systems comfortably while in your listening position. By changing the ID setting of the main unit, up to four AS-50Rs can be operated with one remote control, and it is possible to build an advanced system that can select multiple speakers and amplifiers in all directions.

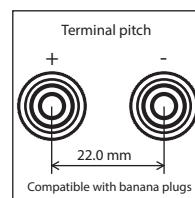

SPECIFICATIONS

Dimensions	297 (W) x 75 (H) x 120 (D) mm
Weight	1.8 kg
Speaker terminal	Supported Y-lug terminal dimension
Width of part a :	22 mm or less
Width of part b :	8 mm or more



* Connection may not be performed depending on the shape of the Y-lug terminal.

*An AC adapter is required to operate this unit.

RCA TERMINAL TYPE COAXIAL LINE SELECTOR

AS-4(III)

A.T 260 €

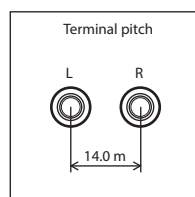
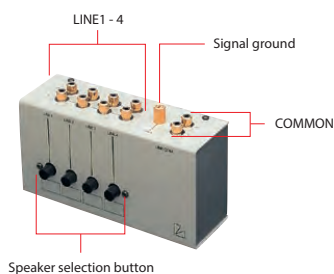

SPECIFICATIONS

Dimensions	160 (W) x 65 (H) x 95 (D) mm
Weight	530 g

SPEAKER TERMINAL TYPE CHANNEL SELECTOR

AS-5(III)

A.T 260 €

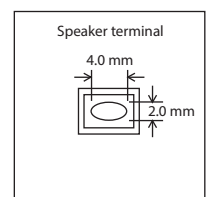
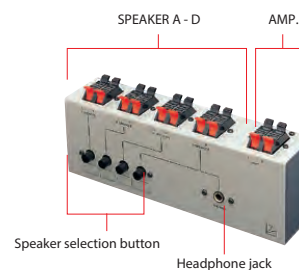

SPECIFICATIONS

Dimensions	240 (W) x 65 (H) x 95 (D) mm
Weight	750 g

AUDIO CABLE / ULTIMATE 15000 SERIES

Our 15000 series line cables feature large diameter core wire utilizing highly-pure 7N CLASS D.U.C.C. (99.99998%+pure copper) to ensure lower impedance. LUXMAN's original techniques, such as the non-twisted structure and binding hot and cold lines in parallel to eliminate unwanted inductance, integrated bound structure for the Left and Right channels to minimize unwanted ground loops and individual shielding for hot and cold transmission lines reducing line-to-line capacitance by half are also featured to yield an unconstrained and lively sound.

*D.U.C.C.(Dia-Ultra Crystallized Copper) is the registered trademark of Mitsubishi Materials Corporation

*Our JPR/JPC-15000 is made from 100 % 7N-Class D.U.C.C. copper and the JPS-15000/2 is made from 60 % 7N-Class D.U.C.C. copper and 40 % OFC copper.



JPC-15000

Λ.T 990 €

Wire length 1.3m XLR type
High-purity 7N-Class D.U.C.C.
(99.99998 % or more copper) conductor
+ high-purity oxygen-free copper (OFC) conductor



JPS-15000/2

Λ.T 3.130 €

Wire length 2.0m speaker cable (Spade plug)
High-purity 7N-Class D.U.C.C.
(99.99998 % + pure copper) core
+ High-purity oxygen-free copper (OFC)

*JPS-15000 comes in 2m



JPR-15000

Λ.T 990 €

Wire length 1.3m RCA type
High-purity 7N-Class D.U.C.C.
(99.99998 % or more copper) conductor
+ high-purity oxygen-free copper (OFC) conductor

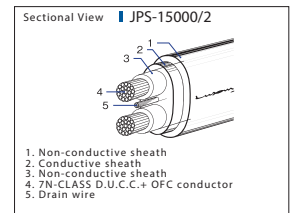
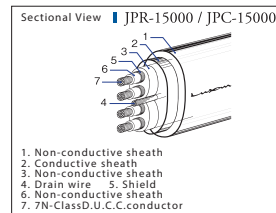

AUDIO CABLE / ULTIMATE 10000 SERIES



JPC-10000

Λ.T 470 €

Wire length 1.25m / XLR type /
High-purity 6N (99.99997 % copper) conductor

Wire length 1.5m / XLR type /
High-purity 6N (99.99997 % copper) conductor



JPR-10000

Λ.T 470 €

Wire length 1.25m / RCA type /
High-purity 6N (99.99997 % copper) conductor

AUDIO CABLE / REFERENCE SERIES



JPC-150

Λ.T 260 €

Wire length 1.5m XLR type /
High-purity oxygen-free copper (OFC) conductor

JPC-100

Λ.T 225 €

Wire length 1.0m XLR type /
High-purity oxygen-free copper (OFC) conductor



JPR-150

Λ.T 200 €

Wire length 1.5m RCA type /
High-purity oxygen-free copper (OFC) conductor

JPR-100

Λ.T 175 €

Wire length 1.0m RCA type /
High-purity oxygen-free copper (OFC) conductor



JPS-100

Λ.T 2.570 €

50 m speaker cable reel
Oxygen Free Copper (OFC) conductor

AUDIO USB CABLE



JPU-150C

Λ.T 150 €

Wire length 1.5m Reference USB cable
high-purity oxygen-free copper (OFC) conductor
USB Type-C → Type-B terminal configuration



JPU-150

Λ.T 150 €

Wire length 1.5m Reference USB cable
high-purity oxygen-free copper (OFC) conductor
USB Type-A → Type-B terminal configuration

TERMINAL PLUG



JPB-10

Λ.T 165 €

Banana plug (4 plugs, boxed)
Machined solid brass
24 K gold-plated



JPY-10

Λ.T 165 €

Spade plug (4 plugs, boxed)
Machined solid brass
24 K gold-plated



* Specifications and appearance are subject to change without notice. * The products listed in this catalog do not include line cables. Please purchase cables separately.

LUXMAN

LUXMAN CORPORATION, 1-3-1 Shinyokohama, Kouhoku-ku, Yokohama-shi, Kanagawa 222-0033, Japan
Tel: +81-45-273-5286 Fax: +81-45-470-6997 www.luxman.com

LUXMAN reserves the right to alter the design and specifications without notice.
All rights reserved LUXMAN CORPORATION



Safety Cautions

To ensure correct use of this product, read the "Owner's Manual" prior to use. Failure to follow all safeguards can result in fire, electric shock, or other accidents.